

Please go to www.quoise.com for product cleaning tips. Go to the **Care + Maintenance** selection.

Tools Required: Flathead screwdriver, Phillips screwdriver, pliers, wire cutters, wire strippers, electrical tape, safety glasses.

Light Source: (3) A19 Medium Base bulbs 100W Maximum or
(3) Medium Base Vintage bulbs are recommended but not supplied.

Estimated Assembly Time: 30-45 minutes

Preparation: Identify and inspect all parts before beginning installation. Check package content list and diagrams below to be sure all parts are present. If any parts are missing or damaged, do not attempt to assemble, install, or operate the fixture. Contact customer service for replacement parts.

⚠ Warnings and Cautions

Turn off electricity at circuit breaker or main fuse box before installation. Consult a licensed electrician if in doubt.

These instructions are provided for your safety. It is very important you read them completely before installing the fixture. We strongly recommend that a licensed, professional electrician perform the installation.

Disconnect fixture from power source before replacing bulbs. Make sure bulbs are given sufficient time to cool before removal.

Package Contents

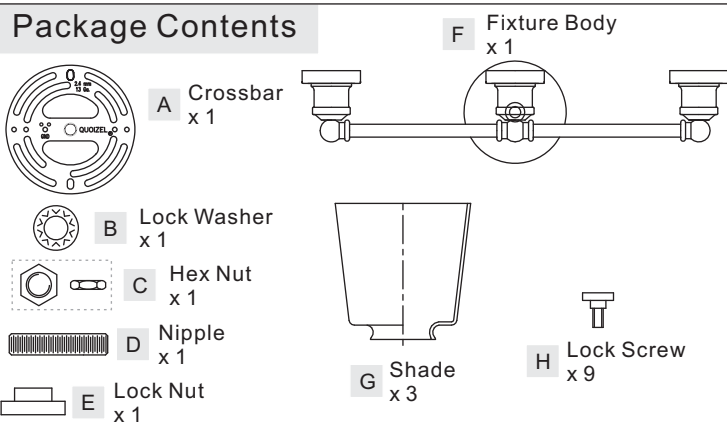

(Step 2 Continued)

- B. Place the Backplate of Fixture Body (F) over the Nipple (D) against the wall to determine the correct position of the Nipple (D). Thread the Lock Nut (E) onto the Nipple (D). Adjust the Nipple (D) to allow the Backplate of Fixture Body (F) to rest against the wall when held in place by the Lock Nut (E).
- C. Remove the Lock Nut (E) and the Fixture Body (F). Tighten the Hex Nut (C) against the Crossbar (A) to secure in place.
- D. Refer to Step 3 for wire connections.
- E. Place the Fixture Body (F) back over the Nipple (D) and secure with Lock Nut (E). Hand tighten until snug.

STEP 3 - Wire Connections

- A. Use standard wire connectors (not included) to make all wire connections. Twist connectors until wires are tightly joined together. Wrap each connection with approved electrical tape and carefully stuff all the connected wires into the Outlet Box.

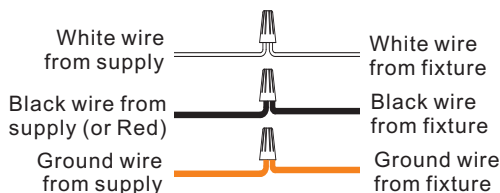

Figure 3

STEP 1 - Install Crossbar

- A. Attach the Crossbar (A) to the Outlet Box with the head of the Green Ground Screw facing you. Secure it with Outlet Box Screws (not included). Tighten until snug.

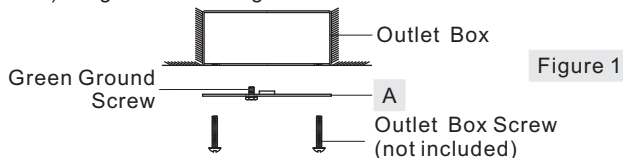

Figure 1

STEP 2 - Install Canopy Chain Loop and Nipple

* Pliers is required for this step.

- A. Thread Hex Nut (C) to the middle of the Nipple (D). Place Lock Washer (B) over the Nipple (D) and then thread the Nipple (D) into the Crossbar (A) until the Nipple (D) is about 0.375" above the Crossbar (A).

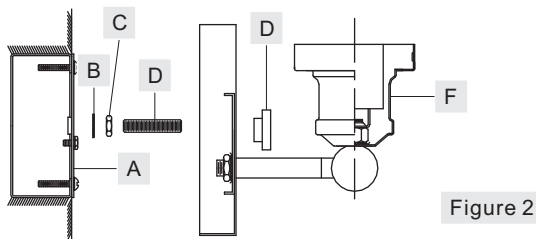

Figure 2

STEP 4 - Install Bulb and Shade

- A. Place Shade (G) into the socket cup properly. Thread Lock Screws (H) onto socket cup to engage the neck of the Shade (G).
- B. Insert bulbs onto sockets and screw snugly into place.

Your fixture is now assembled and ready to use. Enjoy!

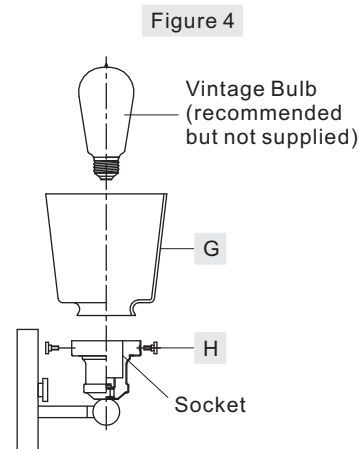

Figure 4

Thank you for purchasing a Quoizel product.
Need assistance with parts or assembly? Call Quoizel customer service at 1-800-645-3184
or visit us on-line at www.quoise.com

UNI8603PK

FINISH: POLISHED NICKEL

NOTE: ALL DIMENSIONS ARE ROUNDED UP TO THE NEAREST 1/4"

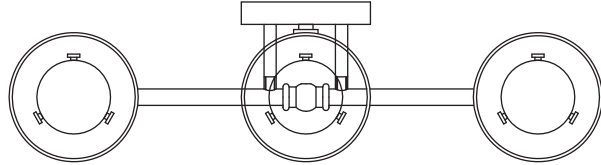
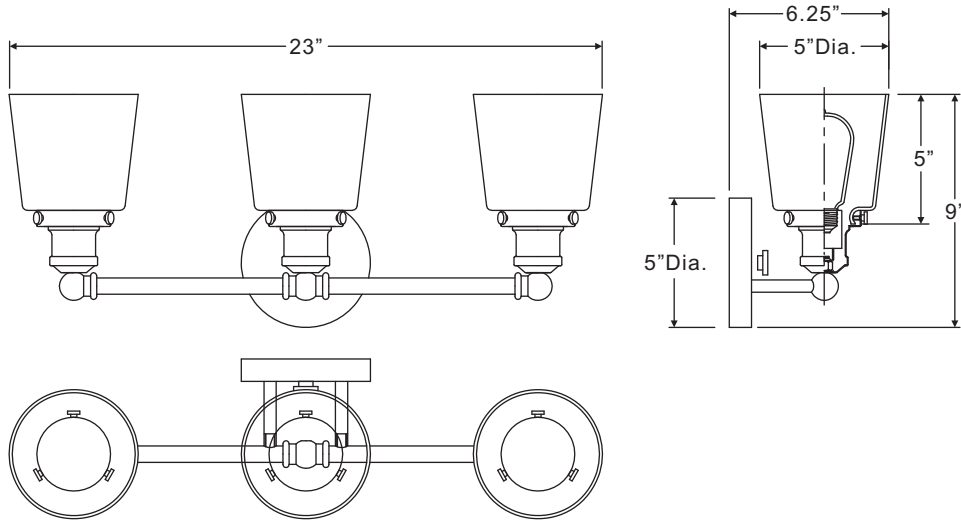

Thank you for purchasing a Quozel product.
Need assistance with parts or assembly? Call Quozel customer service at 1-800-645-3184
or visit us on-line at www.quozel.com