

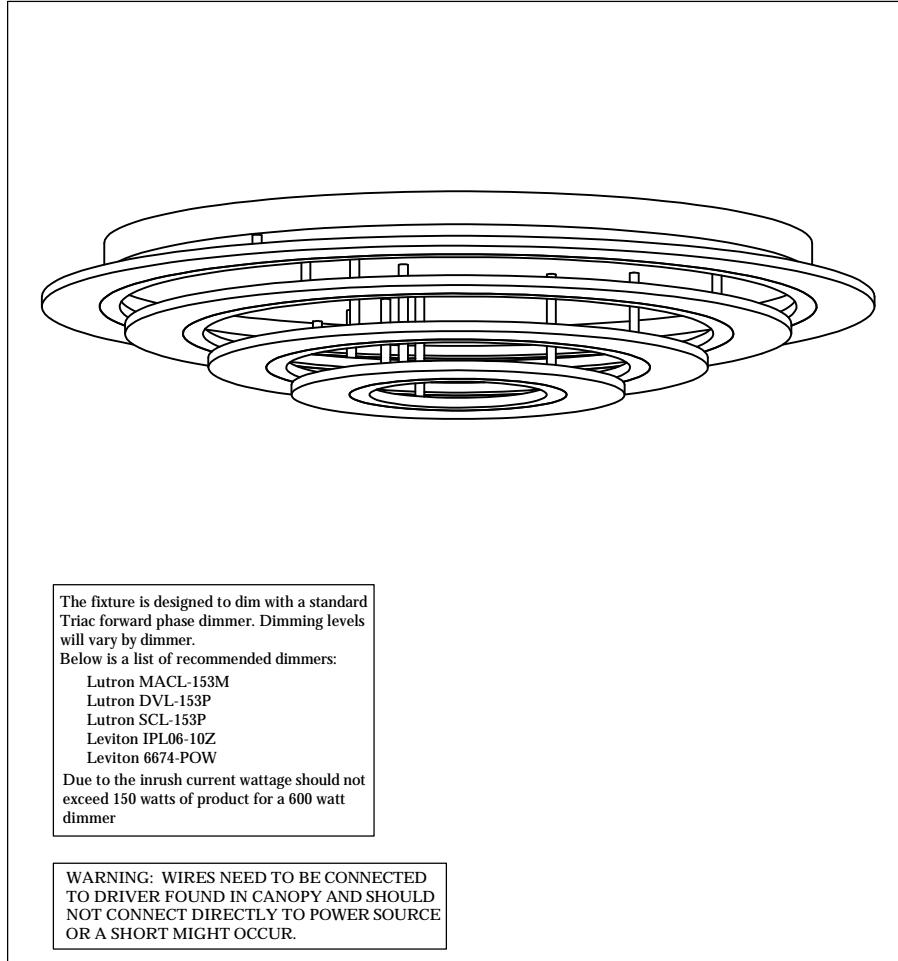

PRODUCT NAME: Saturn II Flush Mount
ITEM NUMBER: E22668-11MS

Please consult your electrician for hanging fixture and wiring.



The fixture is designed to dim with a standard Triac forward phase dimmer. Dimming levels will vary by dimmer.

Below is a list of recommended dimmers:

- Lutron MACL-153M
- Lutron DVL-153P
- Lutron SCL-153P
- Leviton IPL06-10Z
- Leviton 6674-POW

Due to the inrush current wattage should not exceed 150 watts of product for a 600 watt dimmer

WARNING: WIRES NEED TO BE CONNECTED TO DRIVER FOUND IN CANOPY AND SHOULD NOT CONNECT DIRECTLY TO POWER SOURCE OR A SHORT MIGHT OCCUR.

116W LED

IMPORTANT: Turn off the power at the main fuse or circuit breaker box before starting installation

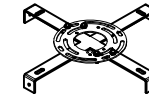

(A)
Mounting Bracket

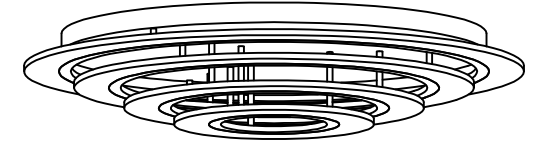

(B)
Canopy

Locate all hardware & components before discarding packaging

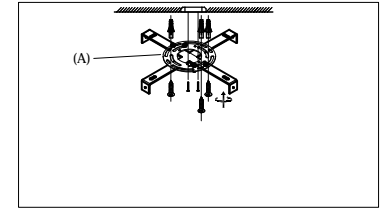
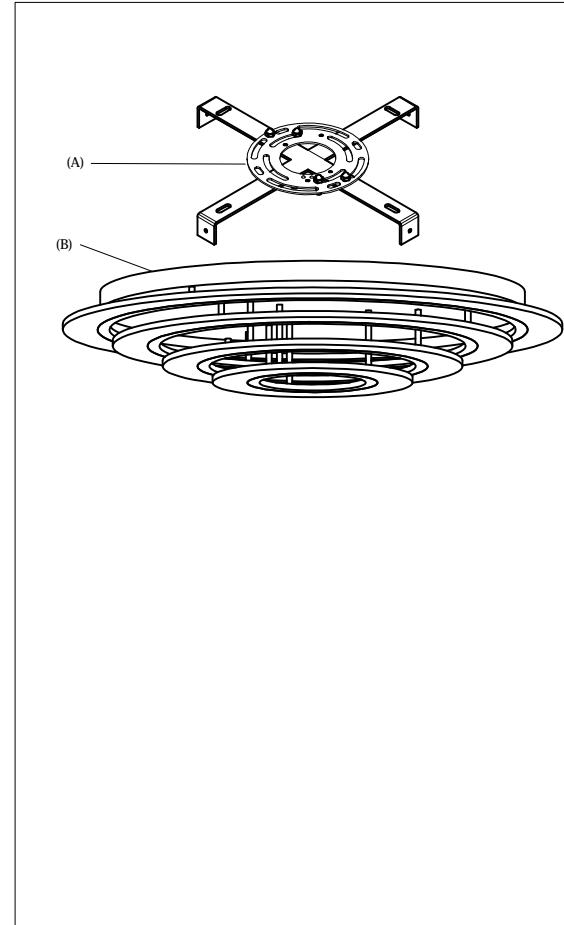

1.)

Step 1: Remove mounting bracket from fixture and install to electrical box. Mark where screws at ends of bracket meet the ceiling. Remove mounting bracket from ceiling. Drill holes using 3/16" ± drill bit where marked. Install mounting bracket to outlet box and attach anchors to secure bracket at ends.

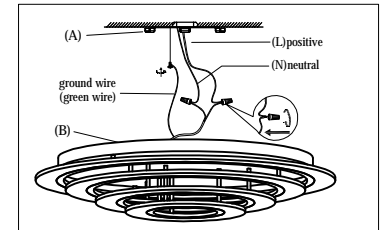

2.)

Step 2: Wire fixture to wires in outlet box. Install Green wire to Ground Screw.

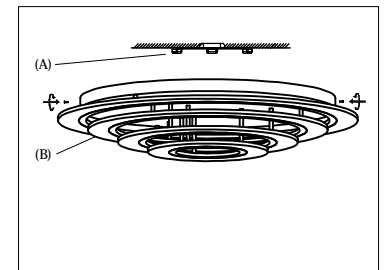

3.)

Step 3: Install Body (B) to Canopy (A) and tighten screws on the sides of the canopy to secure.

Cleaning & Care:
Clean with soft cloth and a mild detergent.
Do not use abrasive cleaner.